

Lesson Eleven

Romans 3:1-8

Romans 3:1-8

Greek / English Interlinear

1) Τί οὖν τὸ περισσὸν τοῦ Ἰουδαίου, ἢ τίς ἡ ὠφέλεια τῆς
What therefore the advantage the of Jew, or what the benefit the

περιτομῆς;
of circumcision?

2) πολὺ κατὰ πάντα τρόπον· πρῶτον μὲν γὰρ ὅτι ἐπιστεύθησαν
much according to every way; first indeed for that they were entrusted

τὰ λόγια τοῦ Θεοῦ.
the oracles the of God.

3) τί γὰρ εἰ ἠπίστησαν τινες; μὴ ἡ ἀπιστία αὐτῶν τὴν πίστιν
what for if disbelieved some? not the unbelief of them the faith

τοῦ Θεοῦ καταργήσει;
the of God will make ineffective?

4) μὴ γένοιτο· γινέσθω δὲ ὁ Θεὸς ἀληθής, πᾶς δὲ ἄνθρωπος
not may it happen; let become but the God true, every and man

ψεύστης, καθὼς γέγραπται, Ὅπως ἂν δικαιωθῆς ἐν
liar, according as it has been written That should you be justified in

τοῖς λόγοις σου, καὶ νικήσης (νικήσεις) ἐν τῷ
the words of you, and you overcome (you will overcome) in the

κρίνεσθαι σε.
to be judged you.

Lesson Eleven

Romans 3:1-8 Greek / English Interlinear

Page 329

5) εἰ δὲ ἡ ἀδικία ἡμῶν Θεοῦ δικαιοσύνην συνίστησι(ν), τί
if and the unrighteousness of us of God righteousness is commending, what

ἐροῦμεν; μὴ ἄδικος ὁ Θεὸς ὁ ἐπιφέρων τὴν ὀργήν,
will we say? not unrighteous the God the One inflicting the wrath,

κατὰ ἄνθρωπον λέγω,
according to man I am speaking.

6) μὴ γένοιτο· ἐπεὶ πῶς κρινεῖ ὁ Θεὸς τὸν κόσμον;
not may it happen; since how will judge the God the world?

7) εἰ γὰρ (δὲ) ἡ ἀλήθεια τοῦ Θεοῦ ἐν τῷ ἐμῷ ψεύσματι
if for (and) the truth the of God in the my lie

ἐπερίσσευσεν εἰς τὴν δόξαν αὐτοῦ, τί ἔτι καγὼ ὡς ἁμαρτωλὸς
did abound for the glory of Him, why yet I also as sinner

κρίνομαι;
being judged?

8) καὶ μὴ, καθὼς βλασφημούμεθα καὶ καθὼς φασί(ν) τινες
and not, according as we were being slandered and according as affirm some

ἡμᾶς λέγειν ὅτι, Ποιήσωμεν τὰ κακά ἵνα ἔλθῃ
us to say that, We should do the evil things in order that should come

τὰ ἀγαθὰ; ὧν τὸ κρίμα ἔνδικον ἐστίν.
the good things? of whom the judgment just is.

Romans 3:1-8
Word Association Diagram

Verse 1

Line 898: (1004) **Τί**
 Line 899: (1005) **οὖν**
 Line 900: (1006) **τὸ**
 Line 901: (1007) **περισσὸν**
 Line 902: (1008) **τοῦ**
 Line 903: (1009) **Ἰουδαίου,**
 Line 904: (1010) **ἣ**
 Line 905: (1011) **τίς**
 Line 906: (1012) **ἣ**
 Line 907: (1013) **ὠφέλεια**
 Line 908: (1014) **τῆς**
 Line 909: (1015) **περιτομῆς;**

Verse 2

Line 910: (1016) **πολὺ**
 Line 911: (1017) **κατὰ**
 Line 912: (1018) **πάντα**
 Line 913: (1019) **τρόπον·**
 Line 914: (1020) **πρῶτον**
 Line 915: (1021) **μὲν**
 Line 916: (1022) **γὰρ**
 Line 917: (1023) **ὅτι**
 Line 918: (1024) **ἐπιστεύθησαν**
 Line 919: (1025) **τὰ**
 Line 920: (1026) **λόγια**
 Line 921: (1027) **τοῦ**
 Line 922: (1028) **Θεοῦ.**

Lesson Eleven
Romans 3:1-8 Word Association Diagram
Page 331

Romans 3:1-8
Word Association Diagram

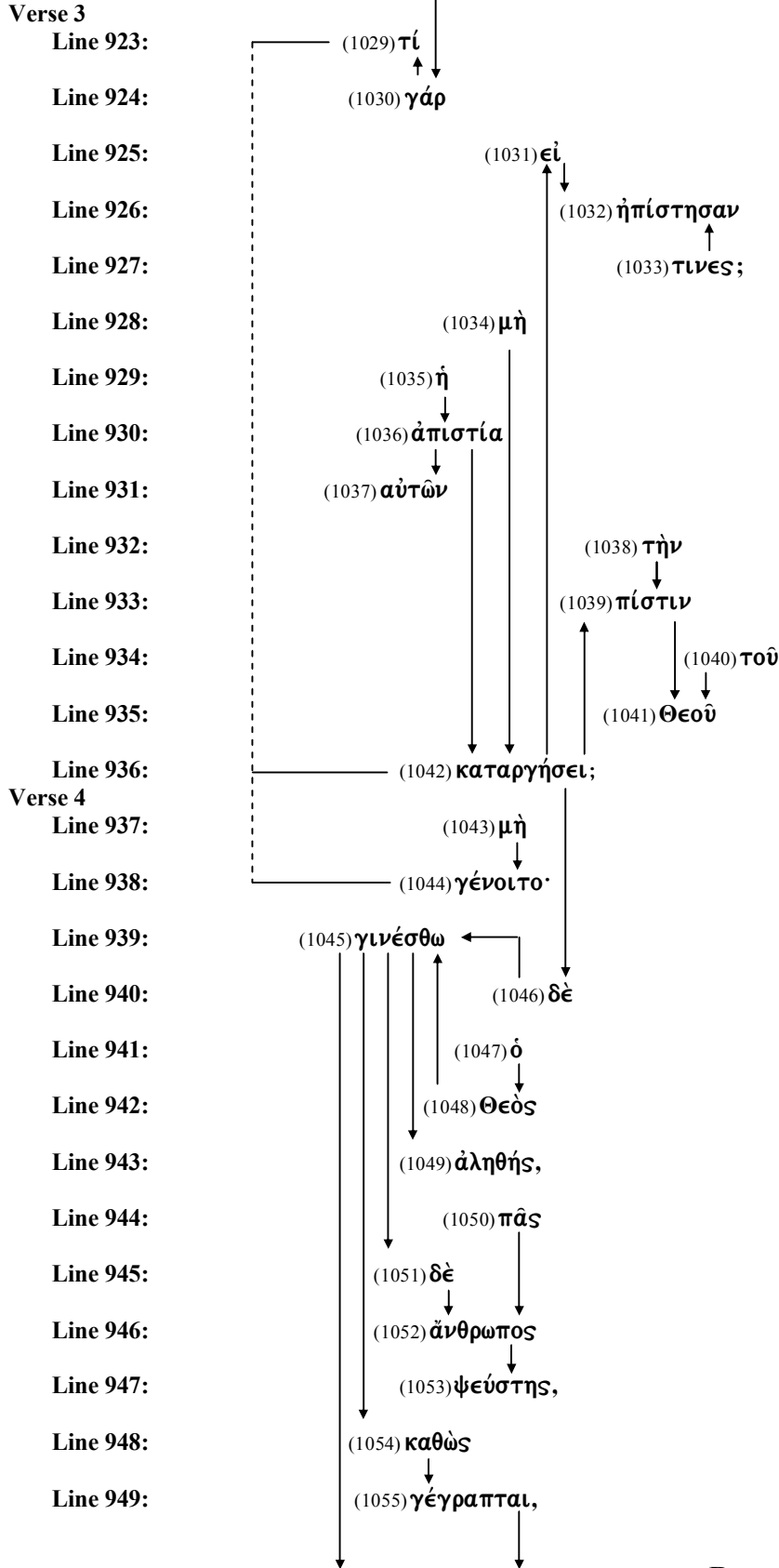

Romans 3:1-8

Word Association Diagram

Verse 4 (cont.)

Line 950:

Line 951:

Line 952:

Line 953:

Line 954:

Line 955:

Line 956:

Line 957:

Line 958:

Line 959:

Line 960:

Line 961:

Line 962:

Verse 5

Line 963:

Line 964:

Line 965:

Line 966:

Line 967:

Line 968:

Line 969:

Line 970:

Line 971:

Line 972:

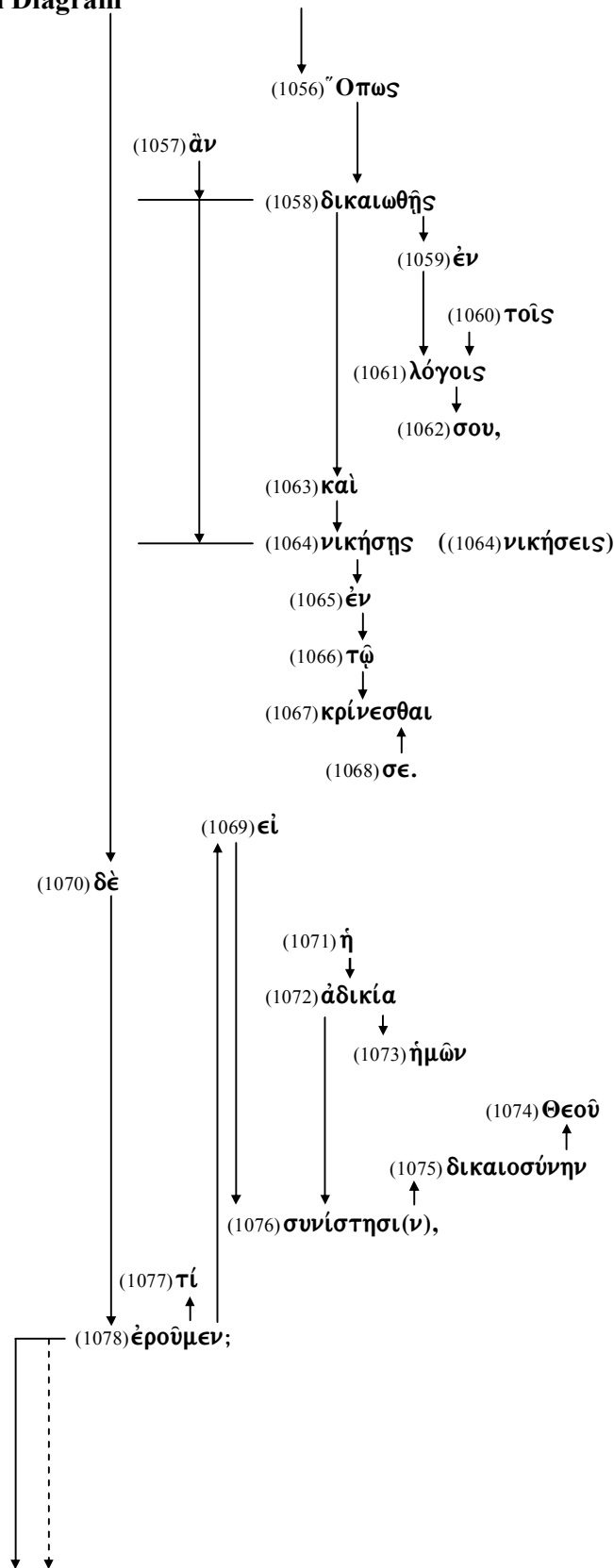

Lesson Eleven

Romans 3:1-8 Word Association Diagram

Romans 3:1-8
Word Association Diagram

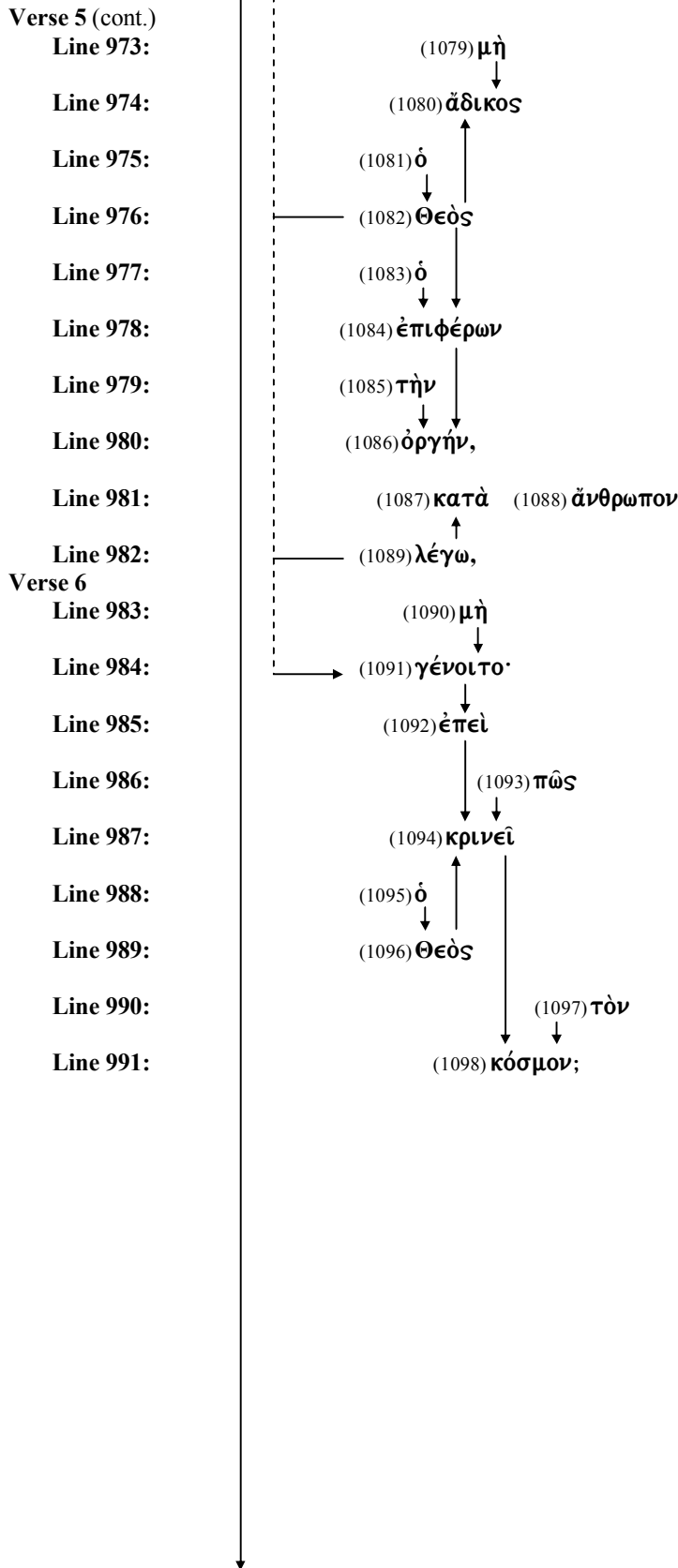

Romans 3:1-8
Word Association Diagram

Verse 7

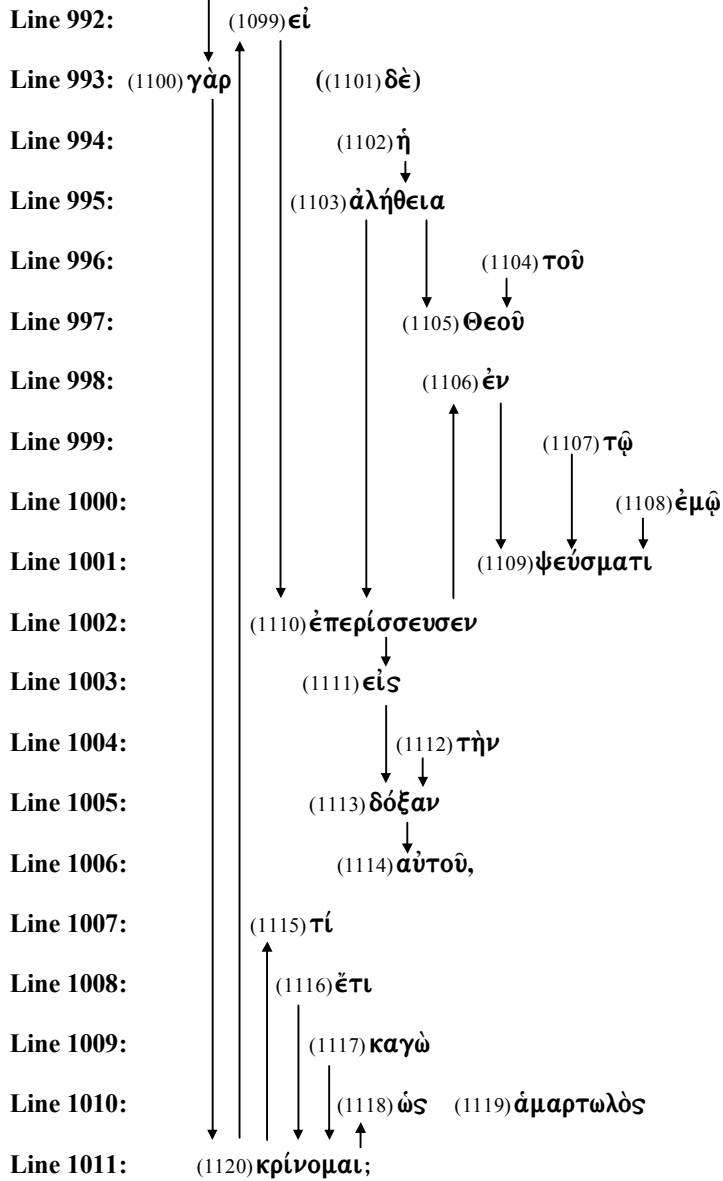

Lesson Eleven
Romans 3:1-8 Word Association Diagram
Page 335

Romans 3:1-8
Word Association Diagram

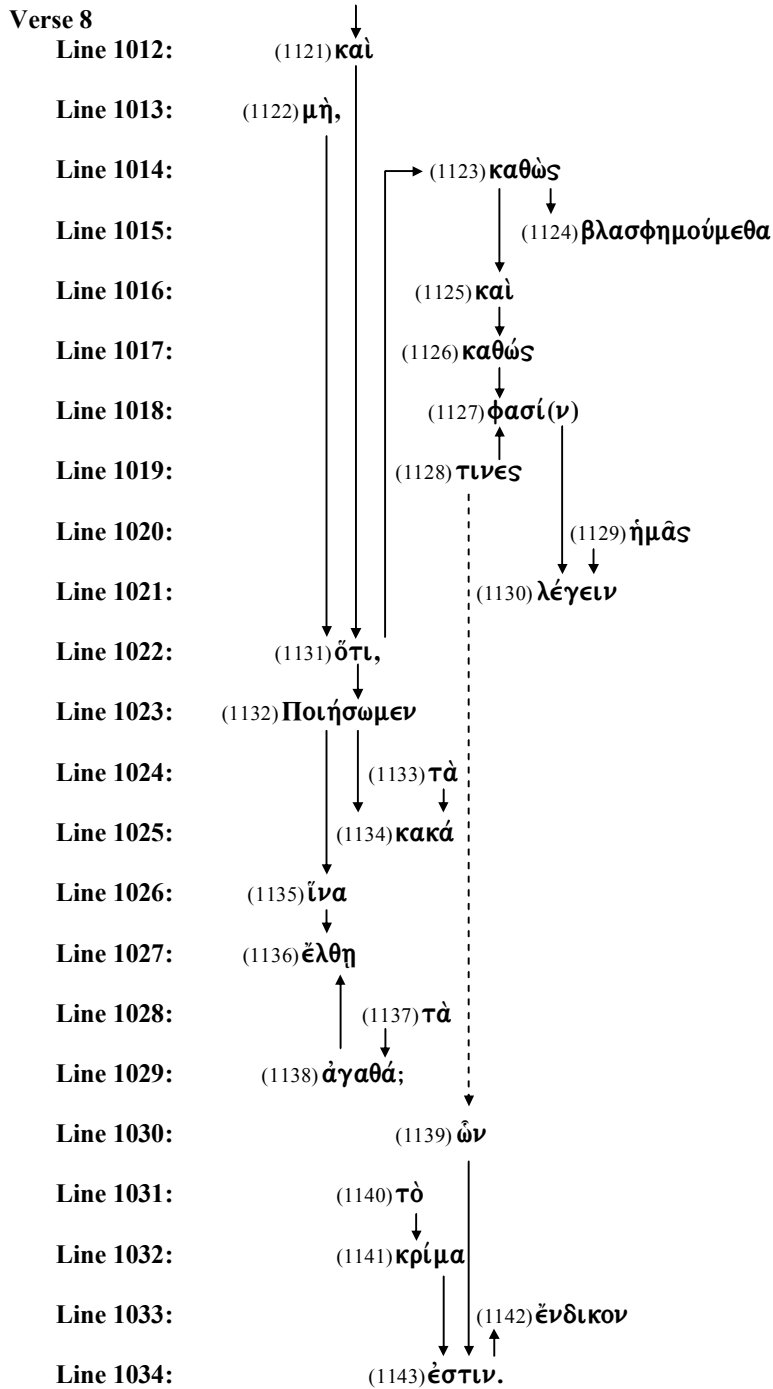

Lesson Eleven

Romans 3:1-8

Diagrams

Romans 3:1-8
Verse 1 Diagram

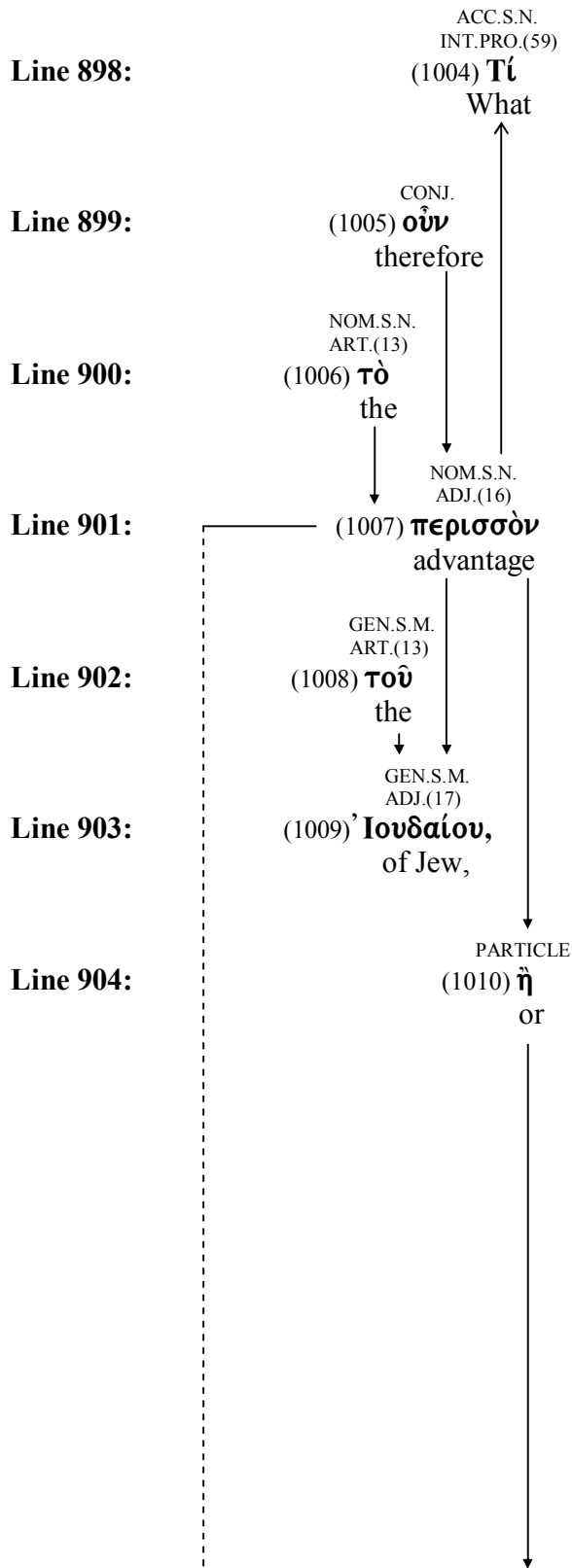

Romans 3:1-8
Verse 1 Word Study

- (1004) **τίς** - interrogative pronoun = who, which, what
- (1005) **οὖν** - particle = therefore, then
- (1006) **ὁ** - article = the
- (1007) **περισσός** - adjective = more, exceeding, abundant
from **περί** - preposition = concerning, about, around
- (1008) **ὁ** - article = the
- (1009) **Ἰουδαῖος** - adjective = Jewish, belonging to the Jewish race.
from **Ἰουδά** - Judah = "He shall be praised"
- (1010) **ἢ** - particle used as a conjunction = or

Romans 3:1-8
Verse 1 Diagram

Line 905:

(1011) τίς
 what

NOM.S.F.
 INT.PRO.(59)

Line 906:

(1012) ἡ
 the

NOM.S.F.
 ART.(13)

Line 907:

(1013) ὠφέλεια
 benefit

NOM.S.F.
 IDEC.N.(15)

Line 908:

(1014) τῆς
 the

GEN.S.F.
 ART.(13)

Line 909:

(1015) περιτομῆς;
 of circumcision?

GEN.S.F.
 IDEC.N.(14)

(1011) **τίς** - interrogative pronoun = who, which, what

(1012) **ὁ** - article = the

(1013) **ὠφελεία** = benefit, gain, profit
from **ὠφέλιμος** = profit, profitable
from **ὄφελος** = advantage, profit

(1014) **ὁ** - article = the

(1015) **περιτομή** = circumcised
from **περιτέμνω** = to cut around
from **περί** - preposition = around
and **τέμνω** = to cut

Romans 3:1-8
Verse 2 Diagram

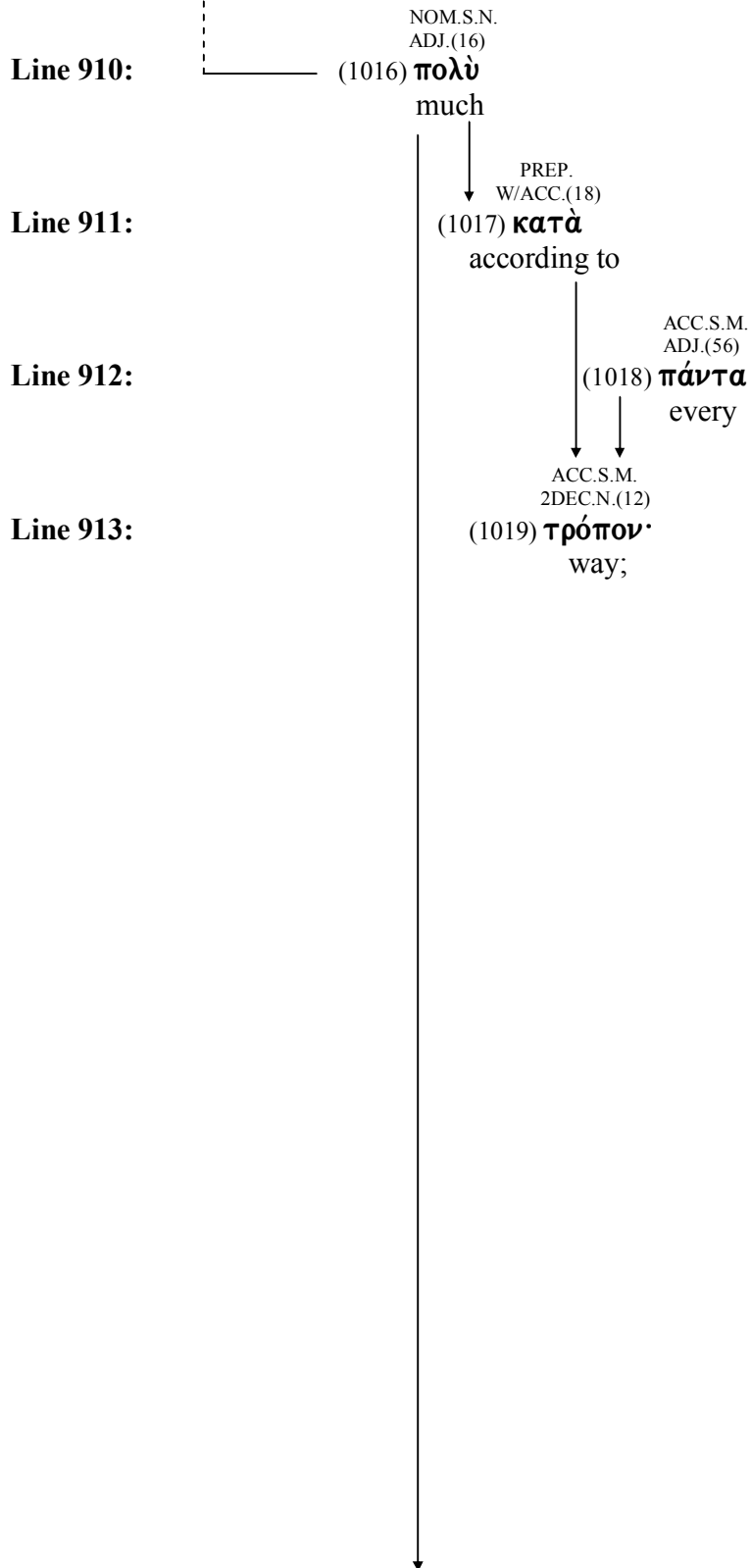

Romans 3:1-8
Verse 2 Word Study

(1016) **πολύς** - adjective = many, much, large

(1017) **κατά** - preposition used with the accusative = according to

(1018) **πᾶς** - adjective = all, every

(1019) **τρόπος** = conduct, character, manner
from **τροπή** = turning

Romans 3:1-8
Verse 2 Diagram

Line 914:

ADV.(67)
 (1020) **πρῶτον**
 first

Line 915:

PARTICLE
 (1021) **μὲν**
 indeed

Line 916:

CONJ.
 (1022) **γὰρ**
 for

Line 917:

CONJ.
 (1023) **ὅτι**
 that

Line 918:

3P.PL.
 AOR.PASS.IND.(37)
 (1024) **ἐπιστεύθησαν**
 they were entrusted

Line 919:

ACC.PL.N.
 ART.(13)
 (1025) **τὰ**
 the

Line 920:

ACC.PL.N.
 3DEC.N.(39)
 (1026) **λόγια**
 oracles

Line 921:

GEN.S.M.
 ART.(13)
 (1027) **τοῦ**
 the

Line 922:

GEN.S.M.
 2DEC.N.(12)
 (1028) **Θεοῦ.**
 of God.

Lesson Eleven
Romans 3:2 Diagram
Page 345

- (1020) **πρῶτος** – adjective = first, chief
from **πρό** - preposition = before
- (1021) **μέν** - particle = truly, certainly, indeed
- (1022) **γάρ** - conjunction = for
- (1023) **ὅτι** - conjunction = that, because
- (1024) **πιστεύω** = to believe, to be persuaded
from **πίστις** = faith
from **πείθω** = to persuade
- (1025) **ὁ** - article = the
- (1026) **λόγιον** = a brief utterance, divine oracle
from **λόγιος** - adjective = eloquent
from **λόγος** = word, speech, account
from **λέγω** = to say, to call
- (1027) **ὁ** - article = the
- (1028) **θεός** = God, deity

Romans 3:1-8
Verse 3 Diagram

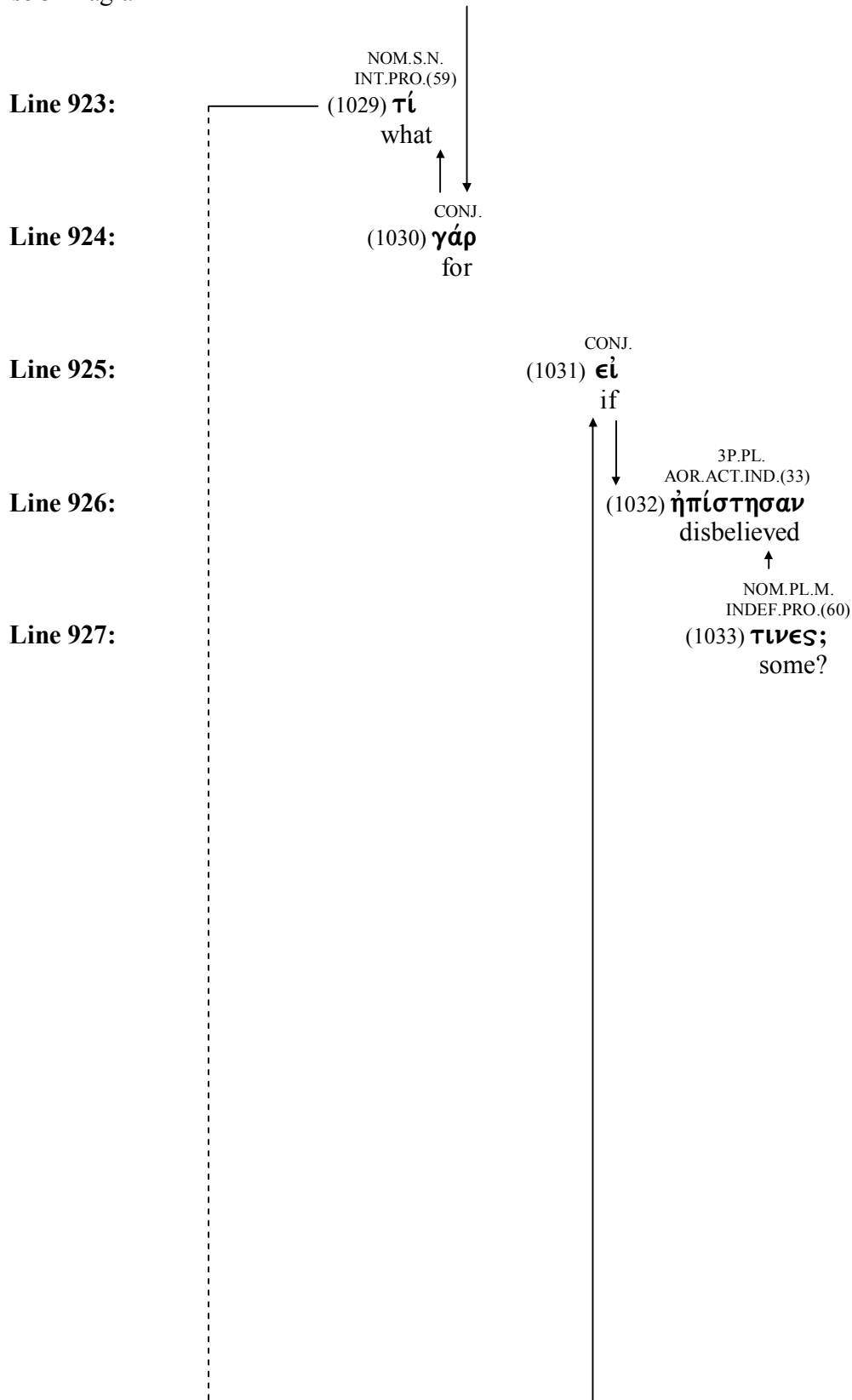

(1029) **τίς** - interrogative pronoun = who, which, what

(1030) **γάρ** - conjunction = for

(1031) **εἰ** - conjunction = if

(1032) **ἀπιστέω** = to disbelieve, to be unfaithful
from **ἄπιστος** - adjective = unfaithful, faithless, unbeliever,
from **α** - used as a negative particle
and **πιστός** - belief, faithful

(1033) **τίς** - indefinite pronoun = some, a certain one

Romans 3:1-8
Verse 3 Diagram

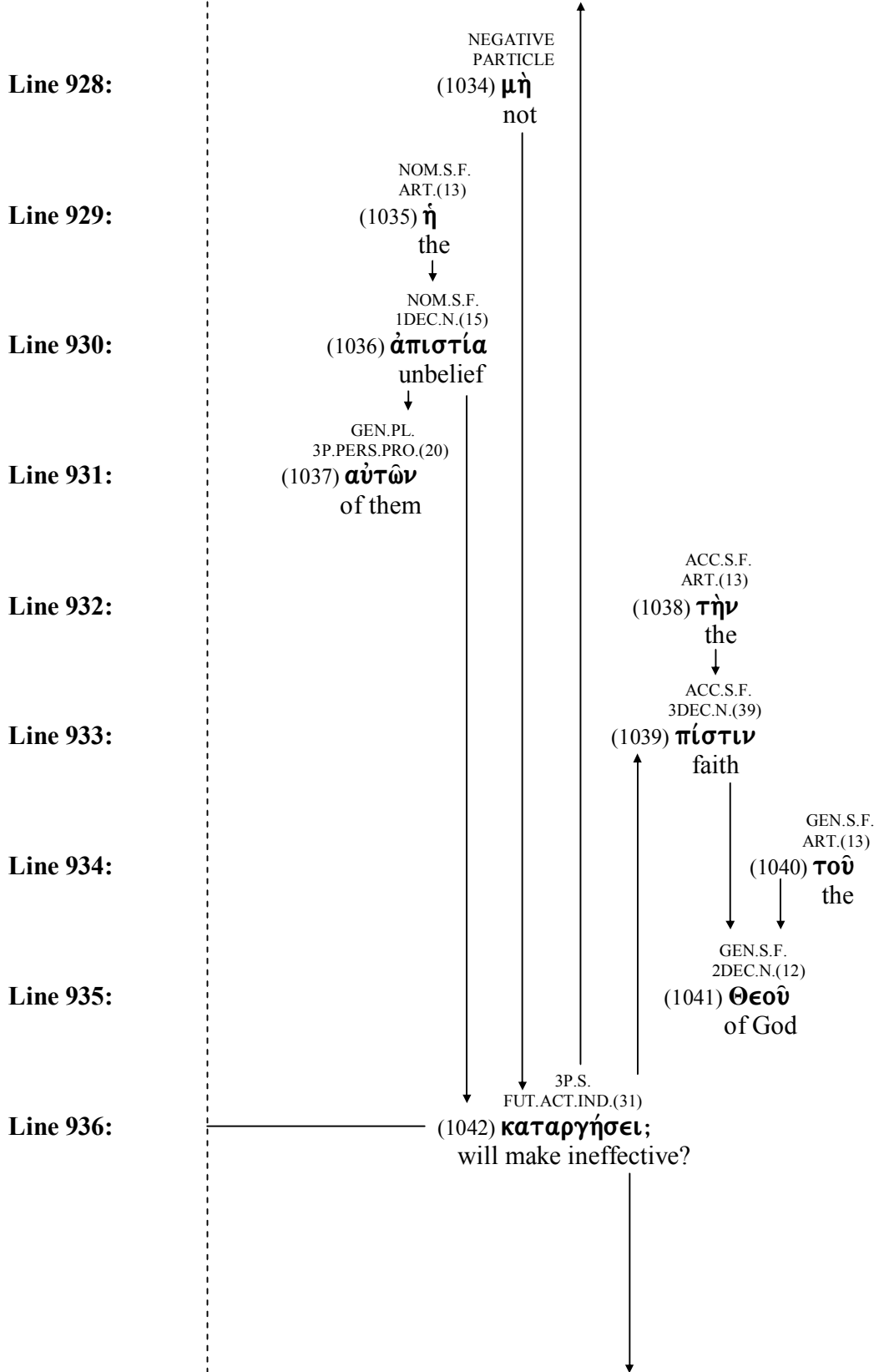

Lesson Eleven
Romans 3:3 Diagram
Page 349

- (1034) **μή** - negative particle = no, not
- (1035) **ὁ** - article = the
- (1036) **ἀπιστία** = unfaithfulness, unbelief, distrust
from **ἄπιστος** - adjective = unfaithful, faithless, unbeliever,
from **α** - used as a negative particle
and **πιστός** - belief, faithful
- (1037) **αὐτός** - third person personal pronoun = he, she, it
- (1038) **ὁ** - article = the
- (1039) **πίστις** - faith
from **πείθω** = to persuade
- (1040) **ὁ** - article = the
- (1041) **θεός** = God, deity
- (1042) **καταργήσει** = make idle, make useless, abolish, destroy
from **κατά** - preposition = according to, against
and **ἀργέω** = to linger, to delay
from **ἀργός** - adjective = idle

Romans 3:1-8
Verse 4 Diagram

Line 937:

NEGATIVE
 PARTICLE
 (1043) **μή**
 not

Line 938:

3P.S.
 AOR.MID.OPT.(68)
 (1044) **γένοιτο**
 may it happen;

Line 939:

3P.S.
 PRES.MID.IMP.(52)
 (1045) **γίνεσθω**
 let become

Line 940:

CONJ.
 (1046) **δέ**
 but

Line 941:

NOM.S.M.
 ART.(13)
 (1047) **ὁ**
 the

Line 942:

NOM.S.M.
 2DEC.N.(12)
 (1048) **Θεός**
 God

Line 943:

NOM.S.M.
 ADJ.(16)
 (1049) **ἀληθής,**
 true,

Line 944:

NOM.S.M.
 3DEC.ADJ.(56)
 (1050) **πᾶς**
 every

Line 945:

CONJ.
 (1051) **δέ**
 and

Line 946:

NOM.S.M.
 2DEC.N.(12)
 (1052) **ἄνθρωπος**
 man

Line 947:

NOM.S.M.
 3DEC.N.(39)
 (1053) **ψεύστης,**
 liar,

Lesson Eleven
Romans 3:4 Diagram
Page 351

- (1043) **μή** - negative particle = no, not
- (1044) **γίνομαι** = to become
- (1045) **γίνομαι** = to become
- (1046) **δὲ** - conjunction = and, now, even
- (1047) **ὁ** - article = the
- (1048) **θεός** = God, deity
- (1049) **ἀληθής** - adjective = truth
from **α** - negative particle = without
and **λανθάνω** = to be hidden, to be secret
- (1050) **πᾶς** - adjective = all, every
- (1051) **δὲ** - conjunction = and, now, even
- (1052) **ἄνθρωπος** = a man, a human being
from **άνήρ** = a male
and **ὄψ** = the face or countenance
- (1053) **ψεύστης** = liar
from **ψεύδομαι** = lie, falsehood

Romans 3:1-8
Verse 4 Diagram

Line 948:

CONJ.
 (1054) **καθὼς**
 according as

Line 949:

3P.S.
 PERF.MID.IND.(53)
 (1055) **γέγραπται,**
 it has been written,

Line 950:

CONJ.
 (1056) **ὡς**
 That

Line 951:

PARTICLE
 (1057) **ἂν**
 should

Line 952:

2P.S.
 AOR.PASS.SUBJ.(49)
 (1058) **δικαιωθῆς**
 you be justified

Line 953:

PREP.
 W/DAT.(18)
 (1059) **ἐν**
 in

Line 954:

DAT.PL.M.
 ART.(13)
 (1060) **τοῖς**
 the

Line 955:

DAT.PL.M.
 2DEC.N.(12)
 (1061) **λόγοις**
 words

Line 956:

GEN.S.
 2P.PERS.PRO.(19)
 (1062) **σου,**
 of you,

Line 957:

CONJ.
 (1063) **καὶ**
 and

Lesson Eleven
Romans 3:4 Diagram
Page 353

- (1054) **καθὼς** - conjunction = according as, just as
from **κατά** - preposition = according to
and **ὡς** - adverb = as, like
- (1055) **γράφω** = to write
- (1056) **ὅπως** - adverb = how, in what way or manner, by what means
from **ὅς** - relative pronoun = who, which, what, that
and **πῶς** - adverb = how, by what means, after what manner, in what way
from **πῶς** - interrogative pronoun = how, in what manner
- (1057) **ἄν** - particle = should
- (1058) **δικαιῶ** = to justify, to make righteous
from **δίκαιος** - adjective = right, just
from **δίκη** = punishment, justice
from **δεικνύω** = to show, to point out
- (1059) **ἐν** - preposition used with the dative = in
- (1060) **ὁ** - article = the
- (1061) **λόγος** = word
from **λέγω** = to speak, to say
- (1062) **σύ** - second person personal pronoun = you
- (1063) **καί** - conjunction = and, also, even

Romans 3:1-8
Verse 4 Diagram

Line 958:

2P.S.
AOR.ACT.SUBJ.(48) (1064) **νικήσης** 3P.S.
PRES.MID.IMP.(52) ((1064) **νικήσεις**)
 you overcome (you will overcome)

Line 959:

PREP.
W/DAT.(18) (1065) **ἐν**
 in

Line 960:

DAT.S.N.
ART.(13) (1066) **τῷ**
 the

Line 961:

PRES.MID.INF.(50)
 (1067) **κρίνεσθαι**
 to be judged

Line 962:

ACC.S.
2P.PERS.PRO.(19) (1068) **σε.**
 you.

Romans 3:1-8
Verse 4 Word Study

(1064) **νικάω** = to conquer, to overcome, to be victorious
from **νίκη** = victory

(1065) **ἐν** - preposition used with the dative = in

(1066) **ὁ** - article = the

(1067) **κρίνω** = to judge, to determine; to separate

(1068) **σύ** - second person personal pronoun = you

Romans 3:1-8
Verse 5 Diagram

Line 963:

CONJ.
 (1069) **εἰ**
 if

Line 964:

CONJ.
 (1070) **δὲ**
 and

Line 965:

NOM.S.F.
 ART.(13)
 (1071) **ἡ**
 the

Line 966:

NOM.S.F.
 IDEC.N.(15)
 (1072) **ἀδικία**
 unrighteousness

Line 967:

GEN.PL.
 1P.PERS.PRO.(19)
 (1073) **ἡμῶν**
 of us

Line 968:

GEN.S.M.
 2DEC.N.(12)
 (1074) **Θεοῦ**
 of God

Line 969:

ACC.S.F.
 IDEC.N.(14)
 (1075) **δικαιοσύνην**
 righteousness

Line 970:

3P.S.
 PRES.ACT.IND.(10)
 (1076) **συνίστησι(ν),**
 is commending,

Line 971:

ACC.S.N.
 INT.PRO.(59)
 (1077) **τί**
 what

Line 972:

IP.PL.
 FUT.ACT.IND.(31)
 (1078) **ἔροῦμεν;**
 will we say?

Lesson Eleven
Romans 3:5 Diagram
Page 357

- (1069) **εἰ** - conjunction = if
- (1070) **δὲ** - conjunction = and, now, even
- (1071) **ὁ** - article = the
- (1072) **ἀδικία** = injustice, wickedness, unjust
from **ἄδικος** - adjective = unjust, unrighteous
from **α** - negative particle
and **δίκη** = justice, punishment
from **δεικνύω** = to show, to point out
- (1073) **ἐγώ** - first person personal pronoun = I
- (1074) **θεός** = God, deity
- (1075) **δικαιοσύνη** = righteousness, justice
from **δίκαιος** - adjective = right, just
from **δίκη** = punishment, justice
from **δεικνύω** = to show, to point out
- (1076) **συνίστημι** = to commend, to recommend, to demonstrate
from **σύν** - preposition = with, in union with
and **ἵστημι** = to stand
- (1077) **τίς** - interrogative pronoun = who, which, what
- (1078) **λέγω** = to say, to speak

Romans 3:1-8
Verse 5 Diagram

Line 973:

NEGATIVE
PARTICLE
(1079) **μη**
not

Line 974:

NOM.S.M.
ADJ.(16)
(1080) **αδικος**
unrighteous

Line 975:

NOM.S.M.
ART.(13)
(1081) **ο**
the

Line 976:

NOM.S.M.
2DEC.N.(12)
(1082) **Θεος**
God

Line 977:

NOM.S.M.
ART.(13)
(1083) **ο**
the One

Line 978:

NOM.S.M.
PRES.ACT.PART.(41)
(1084) **επιφερων**
inflicting

Line 979:

ACC.S.F.
ART.(13)
(1085) **την**
the

Line 980:

ACC.S.F.
1DEC.N.(14)
(1086) **οργην,**
wrath,

Line 981:

PREP.
W/ACC.(18) ACC.S.M.
2DEC.N.(12)
(1087) **κατα** (1088) **ανθρωπον**
according to man

Line 982:

1P.S.
PRES.ACT.IND.(10)
(1089) **λεγω,**
I am speaking,

- (1079) **μή** - negative particle = no, not
- (1080) **ἄδικος** = unrighteous
from **α** - as a negative particle = without
and **δίκη** = right, just; judgment
- (1081) **ὁ** - article = the
- (1082) **θεός** = God, deity
- (1083) **ὁ** - article = the
- (1084) **ἐπιφέρω** = to bring over upon, to inflict
from **ἐπί** - preposition = upon
and **φέρω** = to carry, to bring
- (1085) **ὁ** - article = the
- (1086) **ὀργή** = anger, impulse; any violent expression of emotion
from **ὀρέγω** = to stretch or reach for something
- (1087) **κατά** - preposition used with the accusative = according to
- (1088) **ἄνθρωπος** = a man, a human being
from **ἄνθρω** = a male
and **ὄψ** = the face or countenance
- (1089) **λέγω** = to say, to speak

Romans 3:1-8
Verse 6 Diagram

Line 983:

NEGATIVE
 PARTICLE
 (1090) **μὴ**
 not

Line 984:

3P.S.
 AOR.MID.OPT.(68)
 (1091) **γένοιτο·**
 may it happen;

Line 985:

CONJ.
 (1092) **ἐπεὶ**
 since

Line 986:

ADV.(67)
 (1093) **πῶς**
 how

Line 987:

3P.S.
 FUT.ACT.IND.(31)
 (1094) **κρινεῖ**
 will judge

Line 988:

NOM.S.M.
 ART.(13)
 (1095) **ὁ**
 the

Line 989:

NOM.S.M.
 2DEC.N.(12)
 (1096) **Θεός**
 God

Line 990:

ACC.S.M.
 ART.(13)
 (1097) **τὸν**
 the

Line 991:

ACC.S.M.
 2DEC.N.(12)
 (1098) **κόσμον;**
 world?

Romans 3:1-8
Verse 6 Word Study

- (1090) **μή** - negative particle = no, not
- (1091) **γίνομαι** = to become
- (1092) **ἐπεὶ** - conjunction = since, because, when
from **ἐπί** - preposition = upon, on
and **εἰ** - conjunction = if
- (1093) **πῶς** - adverb = lest, how, in what way
- (1094) **κρίνω** = to judge, to determine; to separate
- (1095) **ὁ** - article = the
- (1096) **θεός** = God, deity
- (1097) **ὁ** - article = the
- (1098) **κόσμος** = world; arrangement, order decoration

Romans 3:1-8
Verse 7 Diagram

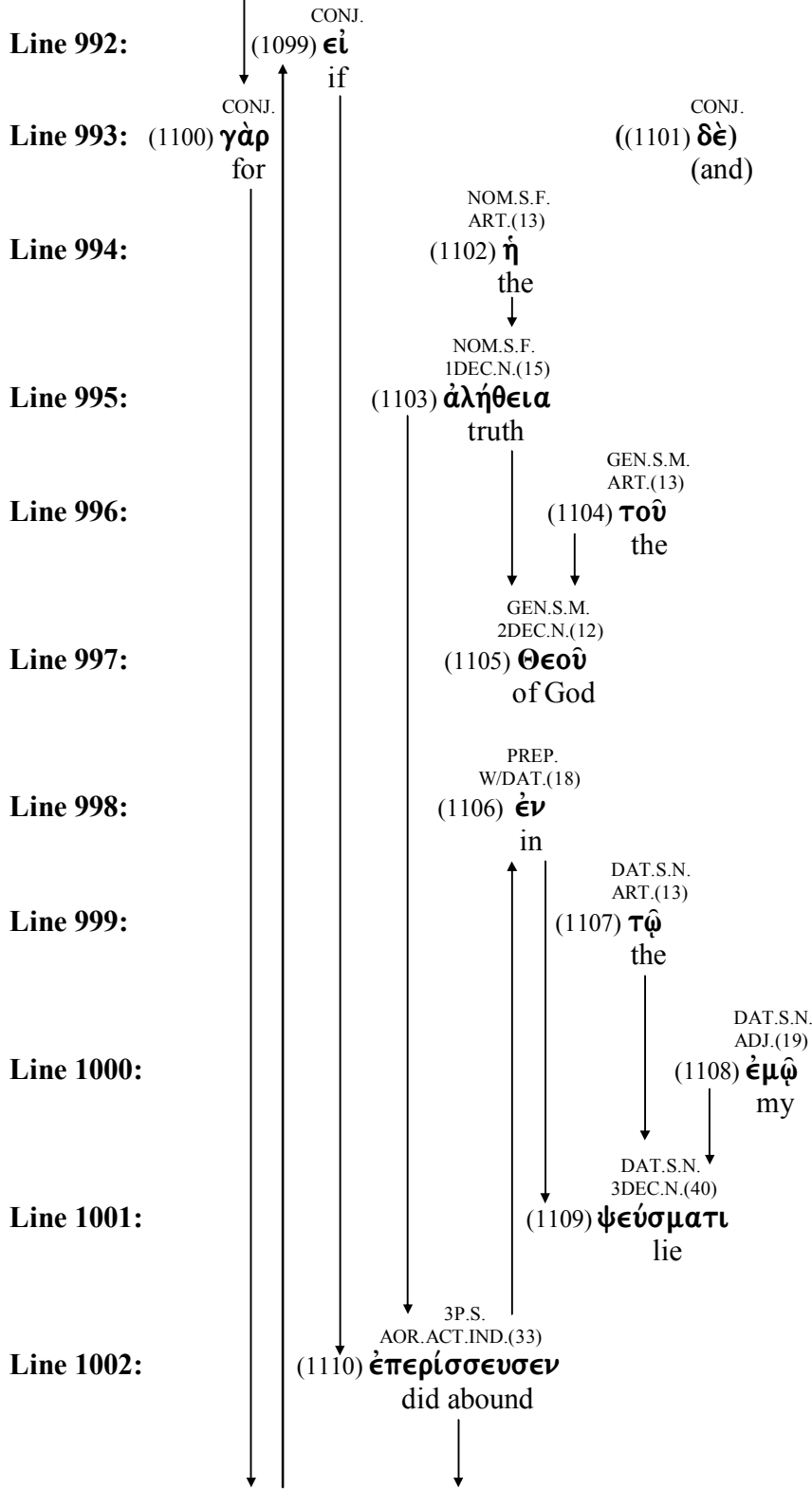

Lesson Eleven
Romans 3:7 Diagram
Page 363

- (1099) **εἰ** - conjunction = if
- (1100) **γάρ** - conjunction = for
- (1101) **δὲ** - conjunction = and, now, even
- (1102) **ὁ** - article = the
- (1103) **ἀλήθεια** = truth
from **ἀληθής** - adjective = truth
from **α** - negative particle = without
and **λανθάνω** = to be hidden, to be secret
- (1104) **ὁ** - article = the
- (1105) **θεός** = God, deity
- (1106) **ἐν** - preposition used with the dative = in
- (1107) **ὁ** - article = the
- (1108) **ἐμός** - first person singular possessive pronoun = my, mine
from **ἐγώ** - first person personal pronoun = I
- (1109) **ψεύσματι** = falsehood, untruthfulness, lie
from **ψεύδομαι** = to lie, to tell a falsehood
- (1110) **περισσεύω** = to abound, to be in abundance
from **περισσός** - adjective = more, exceeding, abundant
from **περί** - preposition = concerning, about, around

Romans 3:1-8
Verse 7 Diagram

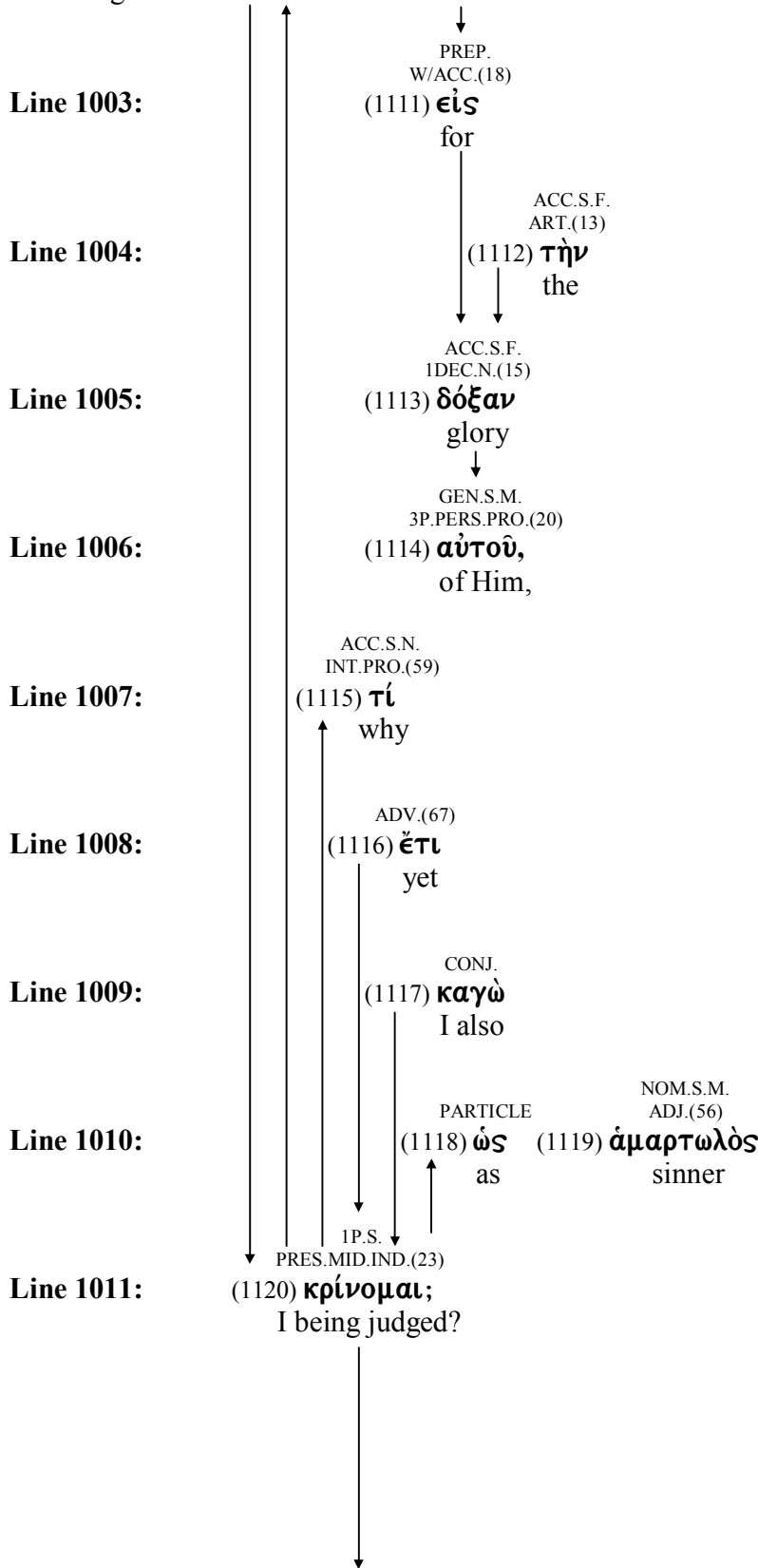

Lesson Eleven
Romans 3:7 Diagram
Page 365

- (1111) **εἰς** - preposition used with the accusative = to, unto, towards
- (1112) **ὁ** - article = the
- (1113) **δόξα** = glory, honor; opinion, judgment, view
from **δοκέω** = to think, suppose, presume; to have an opinion of
- (1114) **αὐτός** - third person personal pronoun = he, she, it
- (1115) **τίς** - interrogative pronoun = who, which, what
- (1116) **ἔτι** - adverb = yet, still
- (1117) **καγὼ** = also I
from **καί** - conjunction = and, also, even
and **ἐγώ** - first person personal pronoun = also I
- (1118) **ὡς** - adverb used as a comparative particle = as, like
from **ὅς** - relative pronoun = who, which, what
- (1119) **ἁμαρτωλός** - adjective = sinful, sinner, heathen
from **ἁμαρτάνω** = to sin
from **α** - negative particle = without
and **μέρος** = measure, portion
- (1120) **κρίνω** = to judge, to determine; to separate

Romans 3:1-8
Verse 8 Diagram

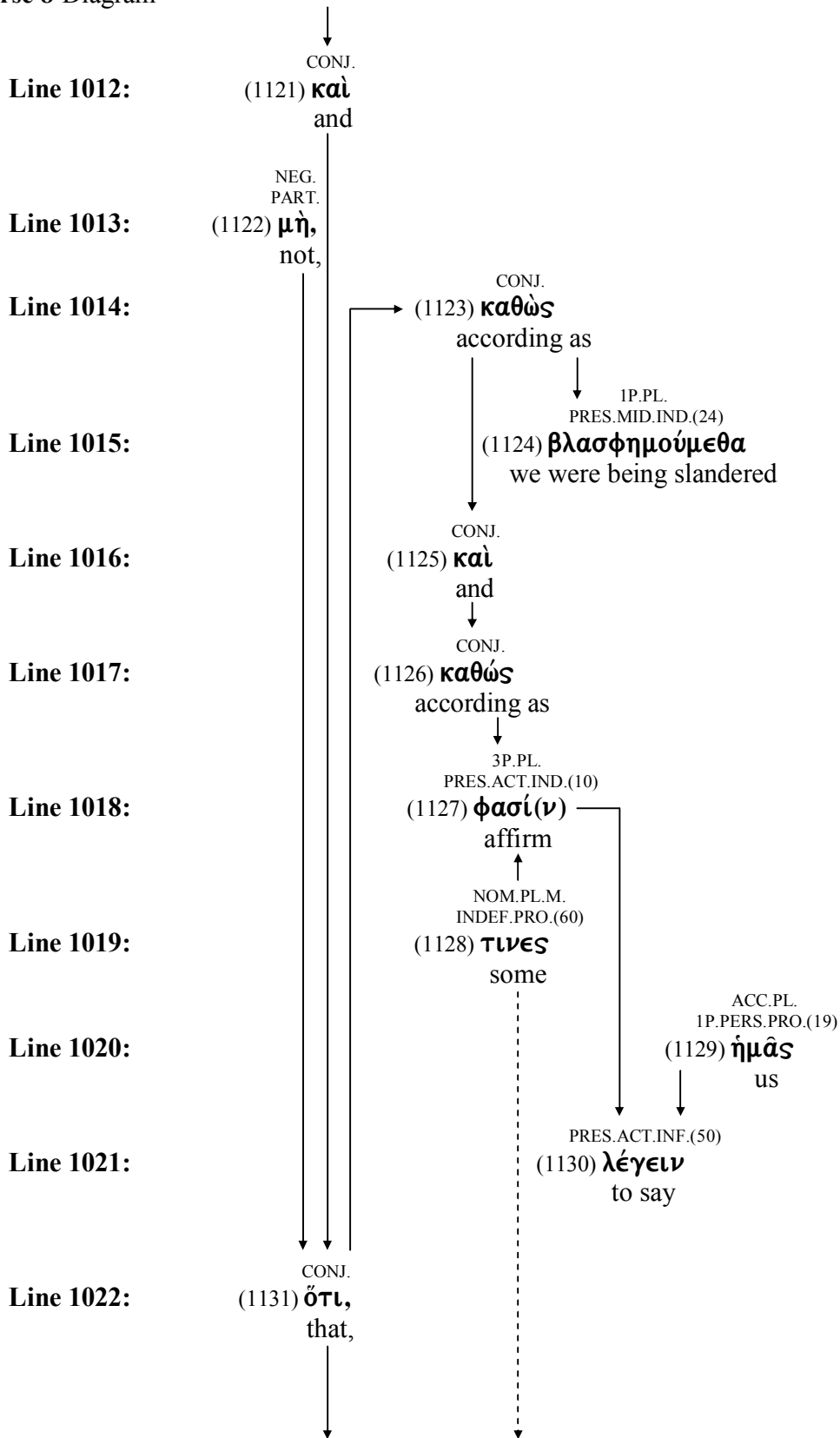

- (1121) **καί** - conjunction = and, also, even
- (1122) **μή** - negative particle = no, not
- (1123) **καθώς** - conjunction = according as, just as
from **κατά** - preposition = according to
and **ὡς** - adverb = as, like
- (1124) **βλασφημέω** = to blaspheme, to slander, to speak evil of
from **βλάσφημος** - adjective = speaking evil, abusive
from **βλάπτω** = to hurt, to harm
and **φήμη** = fame, report
from **φημί** = to say
- (1125) **καί** - conjunction = and, also, even
- (1126) **καθώς** - conjunction = according as, just as
from **κατά** - preposition = according to
and **ὡς** - adverb = as, like
- (1127) **φημί** = to say, to assert, to affirm
from **φῶς** = light
and **φαίνω** = to shine
- (1128) **τίς** - interrogative pronoun = who, which, what
- (1129) **ἐγώ** - first person personal pronoun = I
- (1130) **λέγω** = to say, to speak
- (1131) **ὅτι** - conjunction = that, because

Romans 3:1-8
Verse 8 Diagram

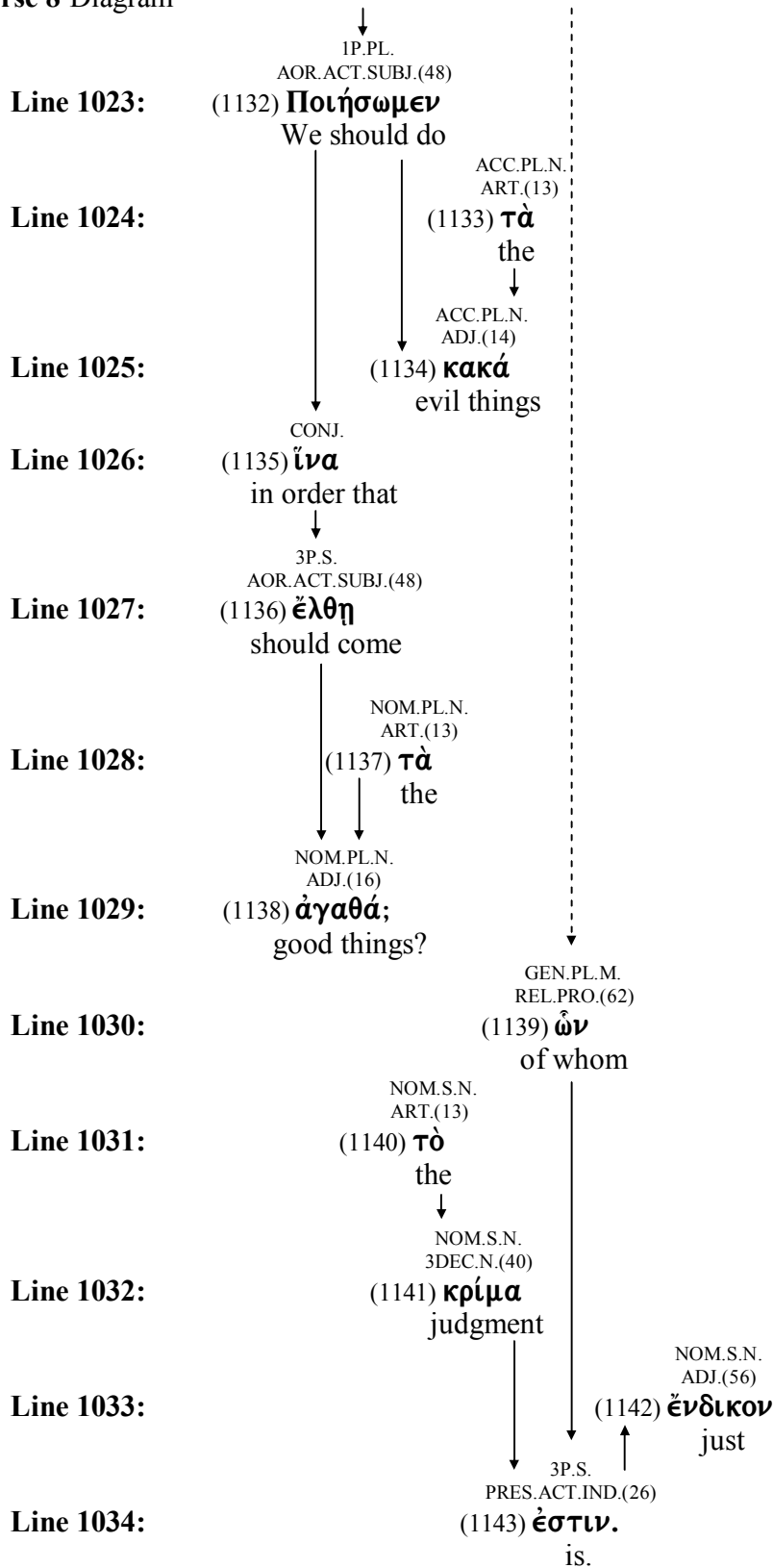

Lesson Eleven
Romans 3:8 Diagram
Page 369

- (1132) **ποιέω** = to make, to do
- (1133) **ὁ** - article = the
- (1134) **κακός** - adjective = bad, harm, evil
- (1135) **ἵνα** - conjunction = that, in order that
- (1136) **ἔρχομαι** = I come, I go
- (1137) **ὁ** - article = the
- (1138) **ἀγαθός** - adjective = good
- (1139) **ὅς** - relative pronoun = who, which, what
- (1140) **ὁ** - article = the
- (1141) **κρίμα** = decree, judgements
from **κρίνω** = to judge, determine; to separate
- (1142) **ἐνδικός** - adjective = to be just, to be in the right
from **ἐν** - preposition = in
and **δίκη** = justice, punishment
from **δεικνύω** = to show, to demonstrate
- (1143) **εἶμι** = to be, exist

Lesson Twelve

Romans 3:9-18

Romans 3:9-18
Greek / English Interlinear

- 9) **Τί οὖν; προεχόμεθα; οὐ πάντως· προητιασάμεθα γὰρ**
What therefore? are we better? not at all; we charged before for
Ἰουδαίους τε καὶ Ἕλληνας πάντας ὑφ' ἁμαρτίαν εἶναι,
Jews both and Greeks all under sin to be,
- 10) **καθὼς γέγραπται ὅτι Οὐκ ἔστι(ν) δίκαιος οὐδὲ εἷς·**
according as it has been written that Not there is righteous not even one;
- 11) **οὐκ ἔστιν ὁ συνίων, οὐκ ἔστιν ὁ ἐκζητῶν τὸν**
not there is the one understanding, not there is the one searching out the
Θεόν·
God;
- 12) **πάντες ἐξέκλιναν, ἅμα ἠξρειώθησαν (ἠχρεώθησαν)· οὐκ**
everyone turned away, together they became useless (they became useless); not
ἔστι(ν) (ὁ) ποιῶν χρηστότητα, οὐκ ἔστιν ἕως ἑνός.
there is (the one) doing goodness, not there is as many as one.
- 13) **τάφος ἀνεφωγμένος ὁ λάρυγξ αὐτῶν, ταῖς γλώσσαις αὐτῶν**
grave having been opened the throat of them, the tongues of them
ἔδολιούσαν· ἰὸς ἀσπίδων ὑπὸ τὰ χεῖλη αὐτῶν·
they were deceiving; poison of asps under the lips of them;

- 14) ὧν τὸ στόμα ἀρᾶς καὶ πικρίας γέμει·
of whom the mouth of cursing and of bitterness is full;
- 15) ὀξεῖς οἱ πόδες αὐτῶν ἐκχέαι αἷμα·
swift the feet of them to shed blood;
- 16) σύντριμμα καὶ ταλαιπωρία ἐν ταῖς ὁδοῖς αὐτῶν,
destruction and misery in the ways of them,
- 17) καὶ ὁδὸν εἰρήνης οὐκ ἔγνωσαν·
and way of peace not they did know;
- 18) οὐκ ἔστι(ν) φόβος Θεοῦ ἀπέναντι τῶν ὀφθαλμῶν αὐτῶν.
no there is fear of God before the eyes of them.

Romans 3:9-18
Word Association Diagram

Verse 9

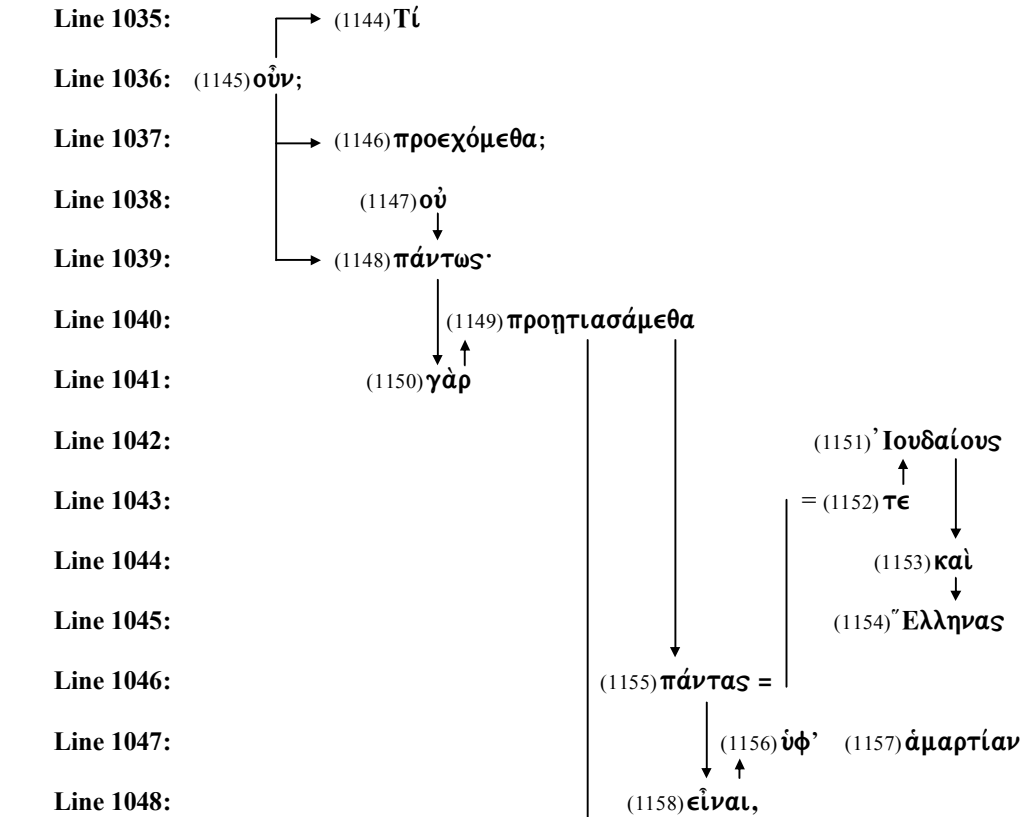

Verse 10

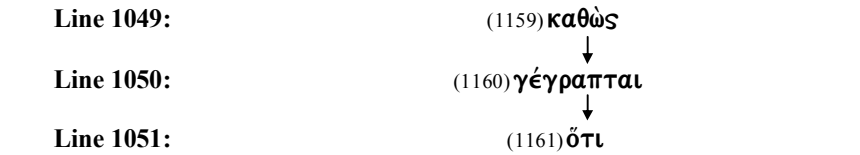

Verse 11



Lesson Twelve
Romans 3:9-18 Word Association Diagram
Page 378

Romans 3:9-18
Word Association Diagram

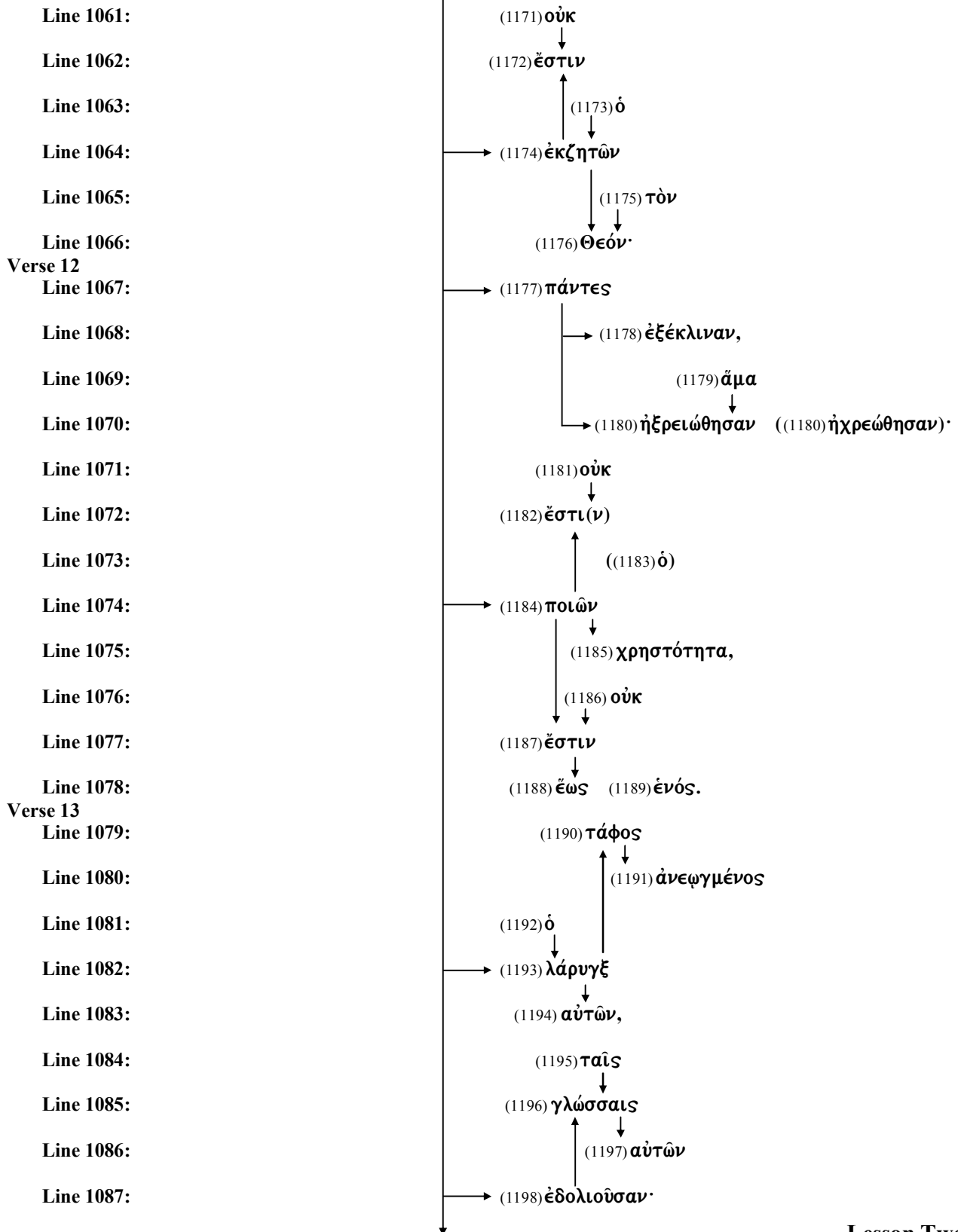

Romans 3:9-18
Word Association Diagram

- Line 1088:
- Line 1089:
- Line 1090:
- Line 1091:
- Line 1092:
- Line 1093:

Verse 14

- Line 1094:
- Line 1095:
- Line 1096:
- Line 1097:
- Line 1098:
- Line 1099:
- Line 1100:

Verse 15

- Line 1101:
- Line 1102:
- Line 1103:
- Line 1104:
- Line 1105:
- Line 1106:

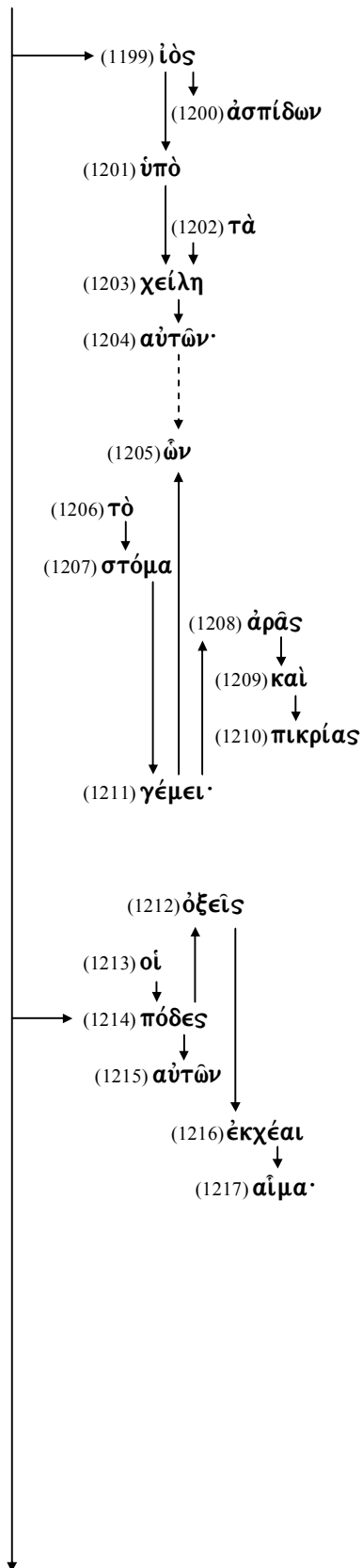

Romans 3:9-18
Word Association Diagram

Verse 16

Line 1107:

Line 1108:

Line 1109:

Line 1110:

Line 1111:

Line 1112:

Line 1113:

Verse 17

Line 1114:

Line 1115:

Line 1116:

Line 1117:

Line 1118:

Verse 18

Line 1119:

Line 1120:

Line 1121:

Line 1122:

Line 1123:

Line 1124:

Line 1125:

Line 1126:

